

### SUMMARY

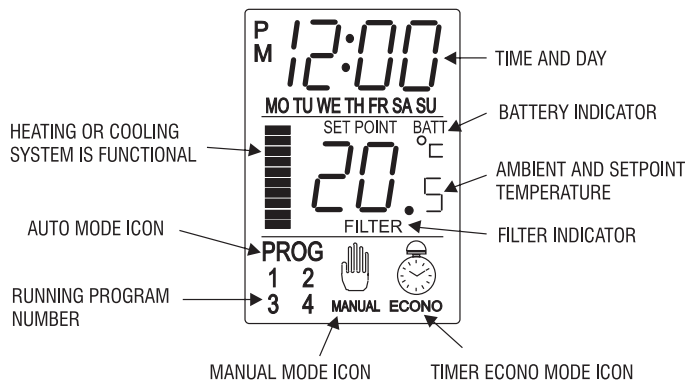
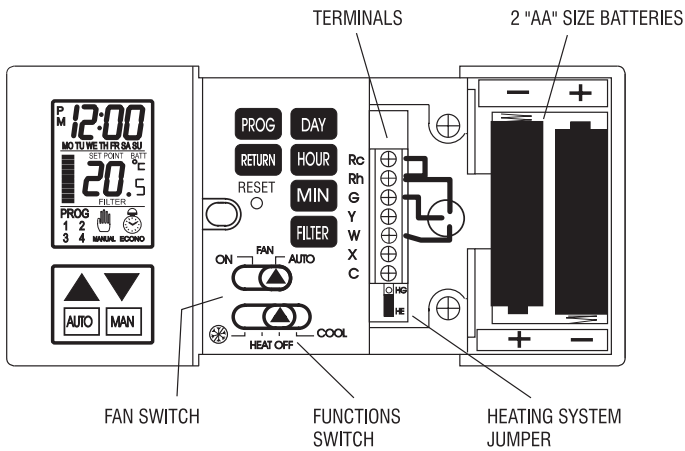

#### TO SET TIME AND DAY

Press DAY, HOUR and MIN keys to adjust the time and day.

#### TO MODIFY HEATING AND COOLING PROGRAMS

- Set the function switch to HEAT position for heating programs and to COOL for cooling programs.
- Use PROG key to select the program to be modified.
- Use HOUR and MIN keys to set the time and ▲ or ▼ button to select the temperature setting.

#### OPERATING MODES

- AUTO:** executes the programs. ▲ or ▼ button shows the temperature setting.
- MAN:** bypasses the programming. ▲ or ▼ changes the temperature setting.
- TIMER ECONO:** maintains the ECONOMIC temperature setting until a user presets time and day.
- ECONO REMOTE:** maintains the ECONOMIC temperature setting as long as an external signal is applied.

#### FILTER FUNCTION

Shows the number of hours that the system has operated since the last filter change. Prevents freezing during your absence.

#### TEMPERATURE SPAN ADJUSTMENT

Press PROG key while RETURN key is pressed in. ▲ or ▼ button changes the span setting.

### INTRODUCTION

This thermostat can replace most common residential thermostats and is designed to be used with electric, gas or oil heating and air conditioning systems using 24 volts control and relay current up to 1.0 ampere.

Several useful functions and operating modes have been incorporated to adapt a variety of customer needs: besides all the features associated with the state of the art programmable thermostat, you'll find on TH123:

- a 7 day timer to set the ECONO mode during a prolonged absence.
- a signal entry to remotely control the ECONO mode.
- a protection against freezing.
- a filter supervision.
- a programmable regulation sensibility (SPAN).

To protect the compressor from damage and wear by cycling on and off too rapidly, the TH123 incorporates a minimum five (5) minutes delay between cooling cycles.

If you have any questions concerning the installation or programming of the thermostat, please call our technical assistance at 1-800-831-AUBE or for the Montreal area, (450) 358-4600 from 8:30 AM to 5:00 PM, Monday through Friday, Eastern time.

### INSTALLATION

This thermostat has been designed for simple and quick installation requiring only a few tools.

#### REQUIRED MATERIAL

- Hammer
- Masking tape
- Drill and 3/16" drill bit
- Phillips screwdriver

#### REMOVING YOUR OLD THERMOSTAT

**WARNING:** To avoid electric shock, turn off the power of the heating and cooling system at the main power box in your home.

Read the following instructions carefully before disconnecting the wires.

- 1 Turn off your old thermostat.
- 2 Remove the cover from the old thermostat. You may have to pull extra hard.
- 3 Unscrew the old thermostat from the wall plate
- 4 Now find the screws attaching the wall plate to the wall, and remove them. You should now be able to pull the wall plate a small distance from the wall. Do not disconnect any wires yet, simply locate the wires.

**Note:** If your old thermostat has only two (2) wires connected to it (heating system only), simply disconnect the two wires from the wall plate, skip over steps 1 and 2 in the Wire labelling section and go on to step 3.

**WARNING:** After removing the wall plate, if you find that it is mounted on a junction box (e.g. a box similar to one behind a light switch or electric outlet), 240 volts circuit may be present and there is a danger of electric shock. Please consult a qualified electrician.

## WIRE LABELLING

- 1 If your old thermostat wall plate has more than two wires connected to it, then you will need to label the wires. First look for LETTER near each terminal where a wire is connected. These terminals and markings may be on either side of the wall plate.
- 2 Disconnect and identify each wire.
- 3 You may wish to tape the wires to the wall to keep them from slipping through the hole in the wall. If the hole in the wall is larger than necessary, fill it in order to prevent hot or cold air to penetrate the thermostat. In this manner, the thermostat will behave perfectly.

## CHOOSING A LOCATION

**Note:** For a new installation, choose a mounting location about five feet (150 cm) above the floor in an area with good air circulation and away from:

Drafts or dead air spots, Air ducts, radiant heat from the sun or appliances, Concealed pipes and chimneys.

## Mounting the thermostat onto the wall

- 1 Remove completely the slide door of the thermostat.
- 2 Unscrew and remove the cover over the connector.
- 3 Mark the holes position and align the wire coming from the wall in the hole beside the connectors.
- 4 Drill two holes and insert the plastic anchors carefully into the holes until they are flush with the wall.
- 5 Fasten securely the thermostat to the wall with the two (2) screws.

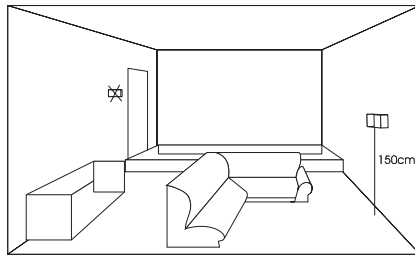

## DISPLAY IN °C OR °F

After the installation of the battery, if you want to change unit of the degree displayed, follow these instructions (see the illustration):

- 1 From the back of the thermostat, unscrew the cover.
- 2 For the °C display, the jumper in JP1 is installed.
- 3 For the °F display, the jumper in JP1 is removed.
- 4 Re-install the cover in place.
- 5 Press on the reset button.

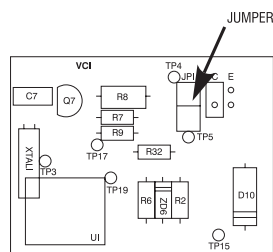

## CONNECTING THE LABELLED WIRES TO THE THERMOSTAT

- 1 Connect the system wires to the terminals according to the wiring diagram shown in the section "wiring diagram".

**WARNING:** Do not remove the jumper between terminals Rh and Rc unless otherwise specified.

- 2 Push on the wires in the wall and replace the cover over the connectors.
- 3 Install two (2) "AA" size batteries into the battery compartment.

- 4 Turn on the main switch of the system. The thermostat is ready for use.

## WIRING DIAGRAM

The TH123 thermostat can be used with any single stage heating and cooling system. You cannot directly use this thermostat on multiple stages heating or cooling system, millivolt system, heat pump or 240 VAC control system. It can control some of those systems by installing an isolation relay and a 24-volt transformer.

## HEATING SYSTEM TYPE

The heating system type selector is located below the wire connector. Start first by keeping the selector at default position Hg. If the fan switch is at FAN AUTO position and the fan doesn't start when the thermostat turns on the furnace, place the type selector at position He.

## 2-WIRE HEATING SYSTEM

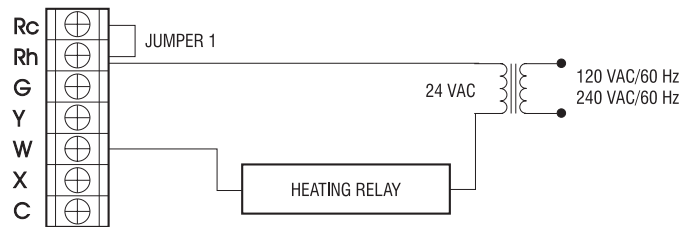

- 1 Connect the heating relay to terminal W.
- 2 Connect the 24 VAC transformer to terminal Rh.

## 3-WIRE HEATING SYSTEM WITH FAN CONTROL

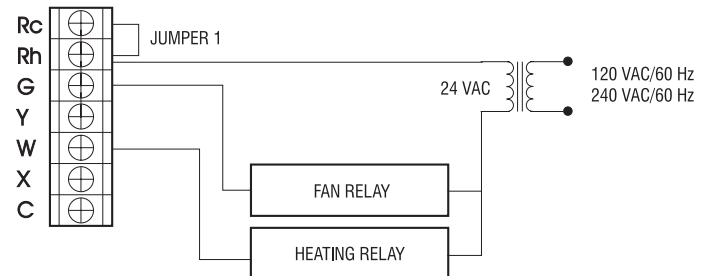

- 1 Connect the heating relay to terminal W.
- 2 Connect the fan relay to terminal G.
- 3 Connect the 24 VAC transformer to terminal Rh.

## 4-WIRE HEATING AND COOLING SYSTEM

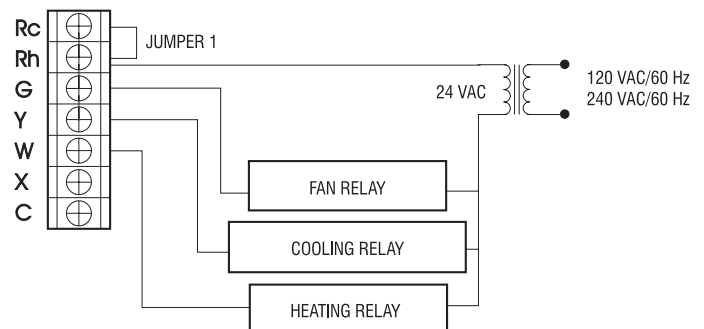

- 1 Connect the heating relay to terminal W.
- 2 Connect the cooling relay to terminal Y.
- 3 Connect the fan relay to terminal G.
- 4 Connect the 24VAC transformer to terminal Rh.

## 5-WIRE HEATING AND COOLING SYSTEM

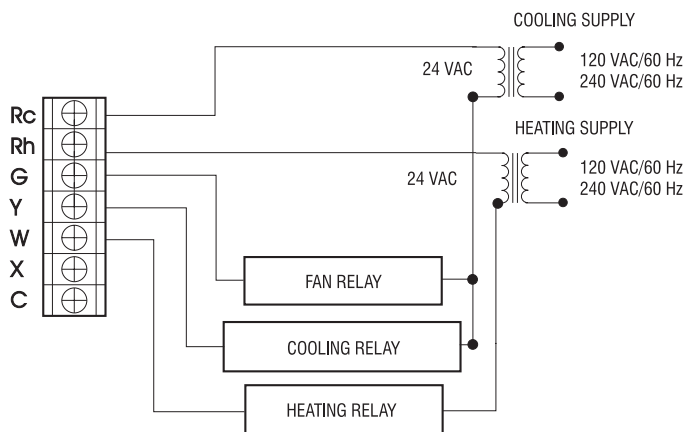

**WARNING:** Remove jumper between terminals Rh and Rc: Both 24 volts returns of the transformers must be connected together in order to have the fan working with the heating and the cooling system. \*Otherwise, the fan will only work with the cooling system.

\*(both transformer supplies, 120/240 vac, must be the same).

- ❶ Connect the heating relay to terminal W.
- ❷ Connect the cooling relay to terminal Y
- ❸ Connect the fan relay to terminal G.
- ❹ Connect the 24VAC heating transformer to terminal Rh.
- ❺ Connect the 24VAC cooling transformer to terminal Rc.

### REMOTE ECONO MODE

Connect the auxiliary system (alarm or domotic system for instance) between the terminals X (positive) and C (negative). The signal from those systems must be 12 to 24 VAC or VDC.

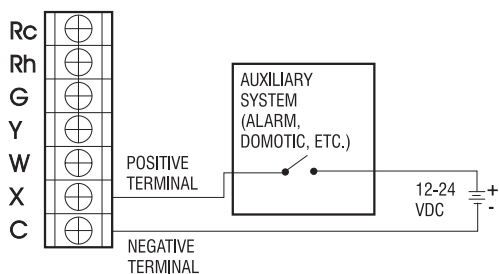
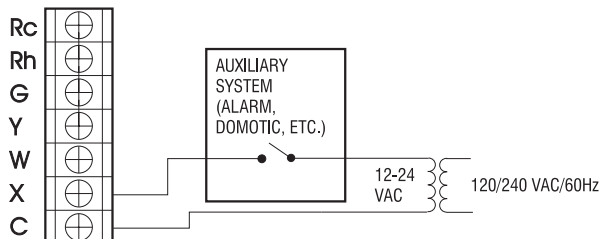

### FIRST POWER-UP

When power is applied for the first time, the display must show time and day as well as the ambient temperature as follows:

If the display is different, press the RESET button. Use a fine probe such as straightened paper clip to gently push the RESET button.

**Note:** Your thermostat is using two (2) "AA" size batteries to protect its memory against a power failure. Even though

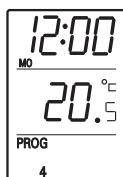

your thermostat will operate without batteries, it is recommended to replace the batteries when the display is showing "BATT".

## OPERATING MODES

The thermostat has four (4) operating modes: AUTOMATIC, MANUAL, TIMER ECONO and REMOTE ECONO.

### AUTO

The AUTOMATIC mode executes in sequence (hourly) the recorded programs.

- ▶ Press on the AUTO button. The "PROG" icon and the running program will be displayed.
- ▶ Pressing ▲ or ▼ button displays the temperature set point of the running program for five (5) seconds.

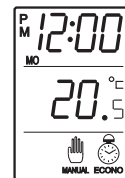

### MAN

The MANUAL mode allows the user to bypass the programming.

- ▶ Press on the MAN button. The  icon will be displayed.
- ▶ A first pressing on ▲ or ▼ displays the MAN temperature set point. Each subsequent pressing will change the MAN temperature set point by 0.5°C (1°F).



### TIMER ECONO

The TIMER ECONO mode holds the ECONO temperature set point until user predetermined time and day is reached. Then, the thermostat turns to AUTOMATIC mode.

This operating mode avoids the user to reprogram his thermostat for a prolonged absence (up to one week) and allows for maximum savings.

- ▶ To get into this operating mode, press and hold MAN button for three (3) seconds.
- ▶ The  icon, the return time and the ECONO temperature set point will be displayed.
- ▶ Press DAY, HOUR and MIN keys to specify the return time.
- ▶ Press ▲ or ▼ button to specify the ECONO temperature set point.

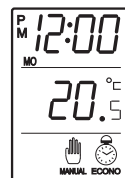

### REMOTE ECONO

An auxiliary system as your alarm or domotic system for instance, can turn your thermostat to ECONO mode. The thermostat holds the ECONO temperature set point as long as the signal of the auxiliary system is applied.

The  icon is flashing to indicate that the auxiliary signal is present.

When the auxiliary signal is removed, the thermostat returns to the previous operating mode (see wiring diagram).

### FUNCTION SWITCH

This switch selects the functions: HEAT, COOL, and OFF.

**HEAT:** Select that position to control the heating system. In AUTO mode, the thermostat will refer to heating programs to control the temperature.

**COOL:** Select that position to control the cooling system. In AUTO mode, the thermostat will refer to cooling programs to control the temperature.

**OFF:** This function shuts off the heating and cooling systems.

This function holds the temperature setpoint at 5°C (40°F) (heating) in order to prevent freezing. It is not programmable.

**FILTER:** The thermostat keeps a record of the number of hours your filter has been used. It will display the total number of hours the system has used the filter from the moment the filter was replaced and that the filter counter was reset to zero. After 250 hours of system operation, the FILTER indicator will begin flashing, to remind you to change or clean the filter and to reset the filter counter back to zero. The filter counter will count up to a maximum 999 hours and stays there until you reset it again. To reset the counter, press and hold the FILTER key until the display shows 000.

## PROGRAMMING

The thermostat has an automatic return. When functions such as the time recording, the program recording, etc. have not been completed by pressing the RETURN key, the thermostat will automatically exit those functions after five (5) or ten (10) seconds.

### TIME AND DAY ADJUSTMENT

- Press DAY, HOUR and MIN to adjust the time and day.
- Press RETURN or wait five (5) seconds for automatic return.

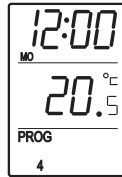

### PRE-RECORDED PROGRAMS

This thermostat has four (4) preprogrammed heating and cooling programs for weekday and two (2) for weekend. They can be used as is or you can modify them at your convenience.

Weekday programs (Mon.... Fri.)			
Prog	Hour	Temperature Setpoints	
		Heating	Cooling
1	6:00 AM	21°C (70°F)	23°C (73°F)
2	8:30 AM	21°C (70°F)	23°C (73°F)
3	4:00 PM	21°C (70°F)	23°C (73°F)
4	11:00 PM	17°C (63°F)	27°C (80°F)
Weekend programs (Sat.& Sun.)			
1	6:00 AM	21°C (70°F)	23°C (73°F)
2	11:00 PM	17°C (63°F)	27°C (80°F)

### PROGRAMMING MODIFICATION

- Place function switch to HEAT position for heating programs or COOL for cooling programs.
- Press the PROG key. The display shows the program's starting time and temperature setpoint. The Monday to Friday indicators are turning on showing that this program is associated to the days of the week. The program number 1 is flashing to indicate the selected program. Pressing again PROG key will scroll weekday programs 1 to 4 and weekend programs 1 and 2.
- Select program to be modified using PROG key.
- Press HOUR and MIN keys to modify program's starting time and ▲ or ▼ buttons to modify program's temperature setpoint.
- Press RETURN key or wait 10 seconds for automatic return.

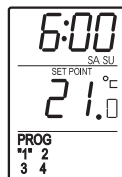

## PROGRAMMING SCHEDULE

Use following programming schedule as a memorandum before programming or changing a program by writing down your schedule of heating and cooling.

Weekday programs (Mon.... Fri.)			
Prog	Hour	Temperature Setpoints	
		Heating	Cooling
1			
2			
3			
4			
Weekend programs (Sat.& Sun.)			
1			
2			

### TEMPERATURE SPAN ADJUSTMENT

The factory set temperature span is 1°C (2°F). For example, if the temperature set point is 20°C (68°F), the heating system will turn on at 19.5°C (67°F) and turn off at 20.5°C (69°F).

This span is programmable. You can choose between 0.5°C (1°F), 1°C (2°F), 1.5°C (3°F) and 2°C (4°F).

To review or to change the temperature span:

- Press PROG while RETURN key is maintained.
- Release both keys.
- Press ▲ or ▼ to select the new span.
- Press RETURN or wait 10 seconds the automatic return



*Note: Choosing a small temperature span such as 0.5°C (1°F) will be more comfortable (less temperature variation in the apartment) but in counter part, the heating or the cooling system will turn on and off more often.*

## CHARACTERISTICS

Model: TH123

Supply: 24 VAC, 50 / 60 Hz

Load: 1 amp maximum

Auxiliary input: 12 to 24 Volts AC/DC

Numbers of programs: 4 weekday programs and 2 weekend programs

Storage temperature range: -20°C to 50°C (0°F to 120°F)

Operating temperature range: 0°C to 50°C (32°F to 120°F)

### AUBE TECHNOLOGIES INC. ONE (1) YEAR LIMITED WARRANTY

This product is warranted against material defects and workmanship in normal use for a period of one year, from the date of the original purchase from authorized dealers. Warranty does not cover transportation costs. Nor does it cover a product subjected to misuse or accidental damage. This limited warranty is in lieu of all other warranties, obligations or liabilities expressed or implied by the company. In no event shall AUBE Technologies inc. be liable for consequential or incidental damages resulting from installation of this product. Within this period, any product proven defective in normal use will be repaired or replaced at AUBE's option, without charge for either parts or labour, provided that the defective product with the original sale receipt is returned to the original dealer or is shipped prepaid, insured and addressed to:

AUBE TECHNOLOGIES INC.

Service centre

705, Monrillard Avenue

Saint-Jean-sur-Richelieu (Quebec)

Canada J2X 5K8

(450) 358-4600 or 1-800-831-2823